

Control Contactor Wall/Pole Mounted

CC602NOEISWPL1C1

Applications

- Highways
- Parking Lots
- Secure Areas
- Industrial Plants
- Schools
- Airports
- Stadiums
- Billboards

Rugged Durable Design

Proven Performance

Real World Tested

Consistent Reliability

Quality Components

Maintenance Friendly

Accessories

6390-TF Photocontrol

RC8744 PhotoClock™

6005 Shorting Cap

To see our full product line,
specification sheets and more,
go to www.ripleylightingcontrols.com

Phone: (803) 939-4700
Fax: (803) 939-4777
Email: info@RipleyLightingControls.com

www.RipleyLightingControls.com

Shown with Photocontrol
(Photocontrol Sold Separately)

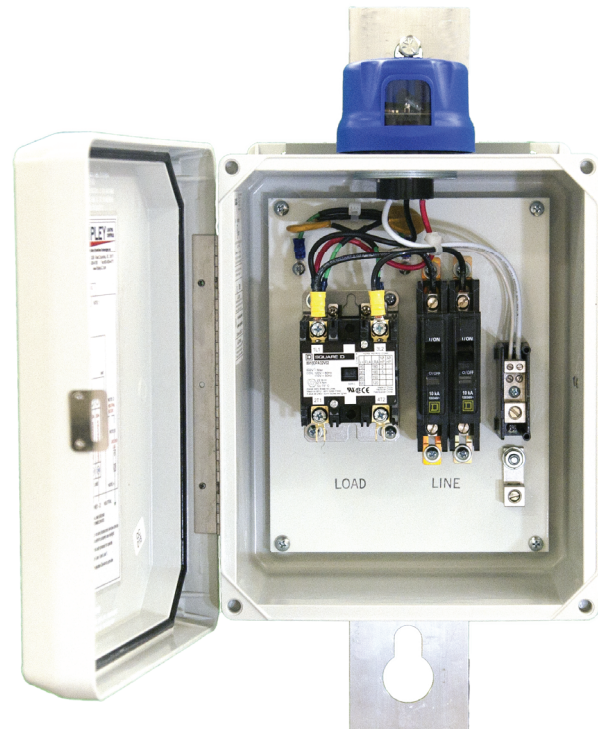

Specifications

- Lighting Contactor
- 120/240 VAC
- 60 AMP
- 2 Pole
- 360° Swivel Photocontrol Receptacle*
- Supply Side (Line) Breaker
- MOV Surge Protection
- Neutral Block & Ground Lug
- Control (Pilot) Voltage 120 VAC
- NEMA 4X Wall Mount Weatherproof Enclosure (10"x8"x5")
- Stainless Steel Padlockable Latch
- Aluminum C-Channel Keyslot Mounting Bracket

CC

60

2

User
Options

120/240

Technical Information Continued on Next Page



Control Contactor Wall/Pole Mounted

Electrical Information

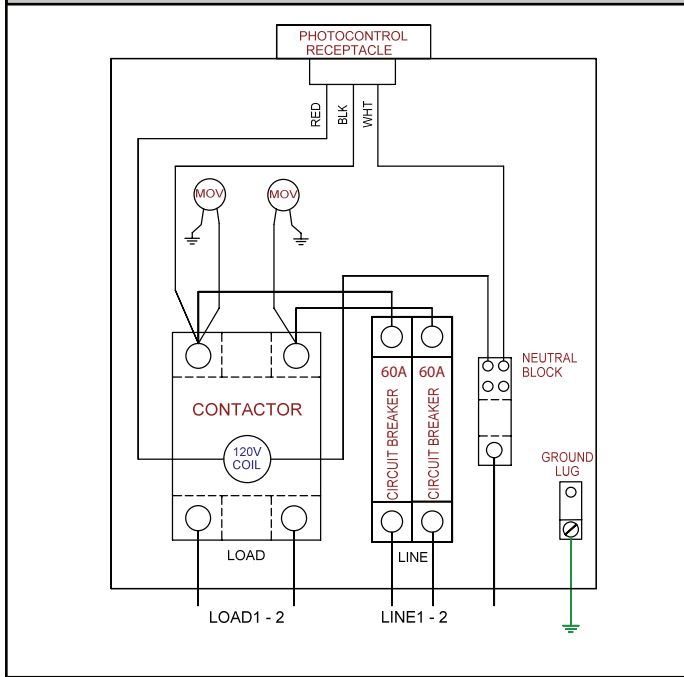

Mechanical Information

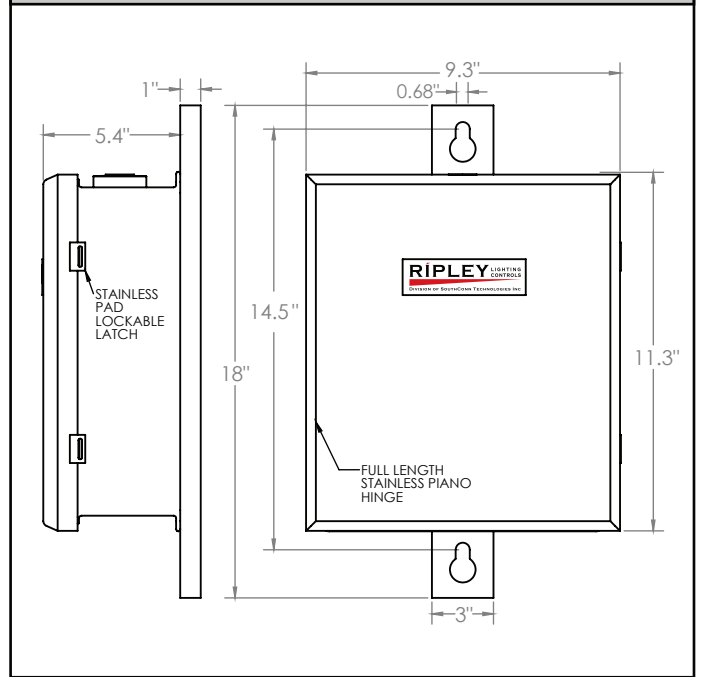

CC602NOEISWPL1C1

Amps (Per Pole)	60
Poles	2
Supply Voltage (Line)	120/240 VAC
Control Voltage (Pilot)	120 VAC
Pilot Type	360° Swivel Photocontrol Receptacle
Switches	Not Applicable
Circuit Load Protection	Supply Side (Line) Breaker
Surge Protection	MOV Internal
Wiring Termination Block	Neutral Block & Ground Lug
Enclosure	NEMA 4X (Weatherproof)
Enclosure Dimensions	10"x8"x5"
Contactor Type	Electromechanical Contactor, N.O.

CC

60

2

User Options

120/240

Ripley Lighting Controls partnering with industry leaders assuring highest quality products.

Meets or exceeds rigid quality requirements of Ripley Lighting Controls.

Phone: (803) 939-4700
 Fax: (803) 939-4777
 Email: info@RipleyLightingControls.com

© 2021 by Ripley Lighting Controls, a Unit of Electroswitch. All rights reserved. The information in this document is provided for informational use only and is subject to change without notice.